



2024

MOTORCYCLE & BIKE SECURITY



Specifications are subject to change without notice. For error, technical mistakes and misprints no liability is assumed.



Kovix Security and Motorcycle Products

2024

ABOUT US

SECURITY CERTIFICATIONS

SECURITY RATING

STEEL THUNDER SERIES

DISC LOCK

smart. LOCK

U LOCK

CHAIN & CABLE LOCK

GRIP LOCK

GROUND ANCHOR

ACCESSORIES

1

10

21

23

26

31

33

35

ABOUT US

1998 - ESTABLISHMENT

In 1998, Kovix began its operations with a dedication to providing high-quality locks that are resistant to attacks and common thefts.

2000 - A NEW PATH OF INNOVATION

Innovation is at the core of Kovix, which not only defines our brand but also shapes our esteemed reputation among our valued customers. In order to enhance our security technologies, we have assembled a team of excellent engineers and established our first Research and Development (R&D) department in 2000.

2004 - VENTURING INTO THE GLOBAL MARKET

Acknowledging the vast potential within the global market, we have strongly believed in our ability to deliver outstanding value to customers worldwide. In 2004, our presence garnered highly positive feedback, motivating us to extend our core principles and offerings beyond local riders.

WHO GONNA TELL THE QUALITY?

As customers' expectations for quality continue to rise, security certificates serve as a testament to the quality of our products.



2021 - PIONEERING THE FIRST ALARM TRAILER COUPLER LOCK

Despite notable advancements in security locks, the theft of valuable outdoor vehicles and equipment continues to be a prevalent issue globally. In response to this ongoing challenge, we introduced the groundbreaking Kovix Outdoor series in 2021. This product line includes a range of Trailer Coupler Locks and Marine Locks. Notably, we take pride in being the first manufacturer to integrate a 120dB alarm with traditional trailer coupler locks, taking their security capabilities to unprecedented levels.

OVERLORD

2022 - NO. WE NEVER STOP TO PROGRESS

In 2022, we introduced the Kovix Overlord series, a new line of disc locks. These locks feature higher visibility and an improved sound outlet, providing louder performance and enhanced security.

2023 - INTRODUCING THE STEEL THUNDER BIKE LOCK SERIES

STEEL THUNDER

In 2023, we proudly present the Steel Thunder Bike Lock Series. This remarkable product line offers a variety of robust security options for cycling enthusiasts. These locks feature an inbuilt 120-decibel alarm, deterring thieves with an ear-piercing sound. To enhance rider confidence, these locks have undergone rigorous testing by independent certification bodies such as the Netherlands ART, French SRA, UK Sold Secure.

A TRUE PROMISE

Throughout the years, our goals have remained unwavering. Kovix is dedicated to delivering high-quality security accessories for outdoor rides. Our steadfast commitment to excellence ensures that our customers can trust in the reliability and effectiveness of our products.



SECURITY CERTIFICATIONS



SRA (SECURITY AND REPAIR OF AUTOMOBILES) is a professional organization established in France in 1977. Part of the SRA's primary mission is to participate in the prevention of vehicle theft. Classe SRA requires a highly detailed drawing of the lock before testing to determine the lock's weakest point. Then, sawing, lever/wedge attack, and drilling tests will be performed to evaluate the security product.



ART Foundation Netherlands promotes security against theft by formulating requirements for mechanical safeguards for two-wheelers. Durability, Weather resistance, Machine, and Manual attack tests are usually performed to testify to the preventive value of a lock. The more stars a lock has, the higher its preventive value and the better it protects against theft. A lock with five stars has the most preventive value.



Sold Secure is the UK's premier testing and certification body for all security products, dedicated to reducing the risk of crime by assessing security products through power tools, machine-based testing, and physical attack testing. Products that have passed a satisfactory evaluation will carry the coveted Sold Secure Approved quality mark.



SP Technical Research Institute Sweden attests to all provisions concerning the assessment and verification of constancy of performance of Mechanically operated locks. Products that fulfill all the prescribed requirements will remain SP accredited as long as the factory production requirements fulfill the harmonized standard used to assess the performance of the declared essential characteristics.

SECURITY RATING



EVERYDAY SAFETY (1-3)

Locks with a security level of 1-3 are suitable for use in low-risk areas and for everyday use in rural areas. They are lightweight, portable, and provide basic safety. Perfect for everyday riders.



MODERATE SAFETY (4-6)

Locks with a security level of 4-6 are suitable for areas with low to medium theft risk and overnight parking in rural areas. They are solid and inbuilt with a 120-decibel siren for added security. Perfect for urban riders.



HIGH SECURITY (7-9)

Locks with a security level of 7-9 are classified as high-security locks. They are effective against physical attacks. They are robust and inbuilt with a 120-decibel siren for added security. Ideal for use in medium to high theft-risk areas, college campuses, or urban areas.



ULTIMATE SECURITY (10-10+)

A security level 10 lock is listed as the highest security class lock. They are effective against physical attacks and virtually indestructible. Accredited by various security certifications for guaranteed quality. Ideal for use in the highest theft-risk areas and overnight in urban areas.



ALARM BOOST

The Alarm Boost feature includes a 120-decibel alarm that can be heard up to 1,500 feet away. The motion sensor detects any tampering or unauthorized movements to the lock, triggering the alarm immediately. Additionally, the lock is equipped with weather resistance features, allowing it to withstand various environmental conditions such as rain, sand, and dust without affecting its reliability.

STEEL THUNDER

Introducing the New STEEL THUNDER Bike Lock Series

The STEEL THUNDER Bike Lock Series is constructed of robust materials such as Stainless Steel and Hardened Steel, providing maximum security and rust resistance for long-lasting protection to cycling enthusiasts. Each lock in the series features an inbuilt 120-decibel alarm to deter thieves with an ear-piercing siren. Combined with the IP67 waterproof certification, these locks are designed to withstand harsh weather conditions and keep the bike safe in any environment.

While to further advance rider's confidence, the new series has been designed to meet and exceed the stringent security qualifications set by independent certification bodies. These qualifications include the Netherlands ART, French SRA, UK Sold Secure, and Sweden SP. These certifications are recognized as the highest standards for bike lock security, highlighting the quality and effectiveness of the new series.

Experience a new level of security with the Kovix STEEL THUNDER Series, designed to provide top-level protection to cyclists.

ROBUST ALARM ASSURED





KFAQ85
FOLDING LOCK



PACKAGE CONTENT

- Built-in 120dB anti-theft security alarm
Alarm function selection ARM / DISARM
- 3 MM** 3mm thick hardened steel plates
330mm internal locking space
High pick and drill resistant disc-style cylinder
- Stainless steel construction
100% rust-proof lock body
Weather-proof electronic module



KCCQ10
CHAIN LOCK



PACKAGE CONTENT

- Built-in 120dB anti-theft security alarm
Alarm function selection ARM / DISARM
- 10 MM** Ø10mm reinforced hardened steel square chain
Durable oxford cloth chain cover for scratch prevention
High pick and drill resistant disc-style cylinder
- Hardened steel lock body
Long lifespan CR2 lithium battery
Weather-proof electronic module



KCCQ12
CHAIN LOCK



PACKAGE CONTENT

- Built-in 120dB anti-theft security alarm
Alarm function selection ARM / DISARM
- 12 MM** Ø12mm reinforced hardened steel square chain
Durable oxford cloth chain cover for scratch prevention
High pick and drill resistant disc-style cylinder
- Hardened steel lock body
Long lifespan CR2 lithium battery
Weather-proof electronic module





KCQ08
CHAIN LOCK

- Built-in 120dB anti-theft security alarm
Alarm function selection ARM / DISARM
- 8 MM** Ø8mm hardened steel chain
Durable webbing sleeve for scratch prevention
High pick and drill resistant disc-style cylinder
- Carbon steel construction
Long lifespan CR2 lithium battery
Weather-proof electronic module



KTQ14-230 SS
U LOCK

- Built-in 120dB anti-theft security alarm
Alarm function selection ARM / DISARM
- 14 MM** Ø14mm hardened Arch-shape U steel shackle
Soft coating to prevent damage to paintwork
High cutting and sawing resistant
High pick and drill resistant disc-style cylinder
- Ideal for locking on frame, back wheel, and bike rack
Stainless steel construction
100% rust-proof lock body
Weather-proof electronic module



PACKAGE CONTENT



KCQ08 LR44
CHAIN LOCK

- Built-in 120dB anti-theft security alarm
Alarm function selection ARM / DISARM
- 8 MM** Ø8mm hardened steel chain
Durable webbing sleeve for scratch prevention
High pick and drill resistant disc-style cylinder
- Carbon steel lock body
LR44 battery
Weather-proof electronic module



KTQ14-230
U LOCK

- Built-in 120dB anti-theft security alarm
Alarm function selection ARM / DISARM
- 14 MM** Ø14mm hardened Arch-shape U steel shackle
Soft coating to prevent damage to paintwork
High cutting and sawing resistant
High pick and drill resistant disc-style cylinder
- Ideal for locking on frame, back wheel, and bike rack
Hardened steel lock body
100% rust-proof lock body
Weather-proof electronic module



PACKAGE CONTENT



LENGTH OPTIONS



PACKAGE CONTENT





PACKAGE CONTENT



KTQ14-300
U LOCK



Built-in 120dB anti-theft security alarm
Alarm function selection ARM / DISARM

14
MM

Ø14mm hardened steel shackle, soft coating to prevent damage to paintwork
High cutting and sawing resistant
High pick and drill resistant disc-style cylinder



Ideal for locking on frame, back wheel, and bike rack
Hardened steel lock body
100% rust-proof lock body
Weather-proof electronic module



PACKAGE CONTENT



KPQ10
PADLOCK



Built-in 120dB anti-theft security alarm
360 degree motion and shock alarm sensor
Alarm function selection ARM / DISARM

10
MM

Ø10mm hardened steel shackle
Ultra cutting and sawing resistant
High pick and drill resistant disc-style cylinder



Ideal for locking gate, door or pair with chain
Stainless steel construction
100% rust-proof lock body
Weather-proof electronic module



PACKAGE CONTENT



KPQ8.5
PADLOCK



Built-in 120dB anti-theft security alarm
360 degree motion and shock alarm sensor
Alarm function selection ARM / DISARM

8.5
MM

Ø8.5mm hardened steel shackle
Ultra cutting and sawing resistant
High pick and drill resistant disc-style cylinder



Ideal for locking gate, door or pair with chain
Stainless steel construction
100% rust-proof lock body
Weather-proof electronic module



PACKAGE CONTENT



KPQ12
PADLOCK



Built-in 120dB anti-theft security alarm
360 degree motion and shock alarm sensor
Alarm function selection ARM / DISARM

12
MM

Ø12mm hardened steel shackle
Ultra cutting and sawing resistant
High pick and drill resistant disc-style cylinder



Ideal for locking gate, door or pair with chain
Stainless steel construction
100% rust-proof lock body
Weather-proof electronic module



KHS 16N + KC12-120
CHAIN LOCK

16 MM Ø16mm hardened steel shackle
Ultra cutting and sawing resistant
High pick and drill resistant disc-style cylinder

120 CM Full hardened steel construction
Ø12mm Reinforced hardened steel SQUARE chain

KHS 16N + KC12-150
CHAIN LOCK

16 MM Ø16mm hardened steel shackle
Ultra cutting and sawing resistant
High pick and drill resistant disc-style cylinder

120 CM Full hardened steel construction
Ø12mm Reinforced hardened steel SQUARE chain

DISC LOCK

Robust Siren Disc Brake Lock against motorcycle thefts.

Premium steel construction, pick-proof disc style lock cylinder and high performance 120-decibels sound outlet.



KHS 16N

DISC LOCK/ PADLOCK



16 MM Ø16mm hardened steel shackle
Ultra cutting and sawing resistant
High pick and drill resistant disc-style cylinder



Hardened steel construction
Use as disc brake lock or pair with chain



KHS16

DISC LOCK/ PADLOCK



16 MM Ø16mm hardened steel shackle
Ultra cutting and sawing resistant
High pick and drill resistant disc-style cylinder



Stainless steel construction
100% rust-proof lock body
Use as disc brake lock or pair with chain

OUR MECHANISM

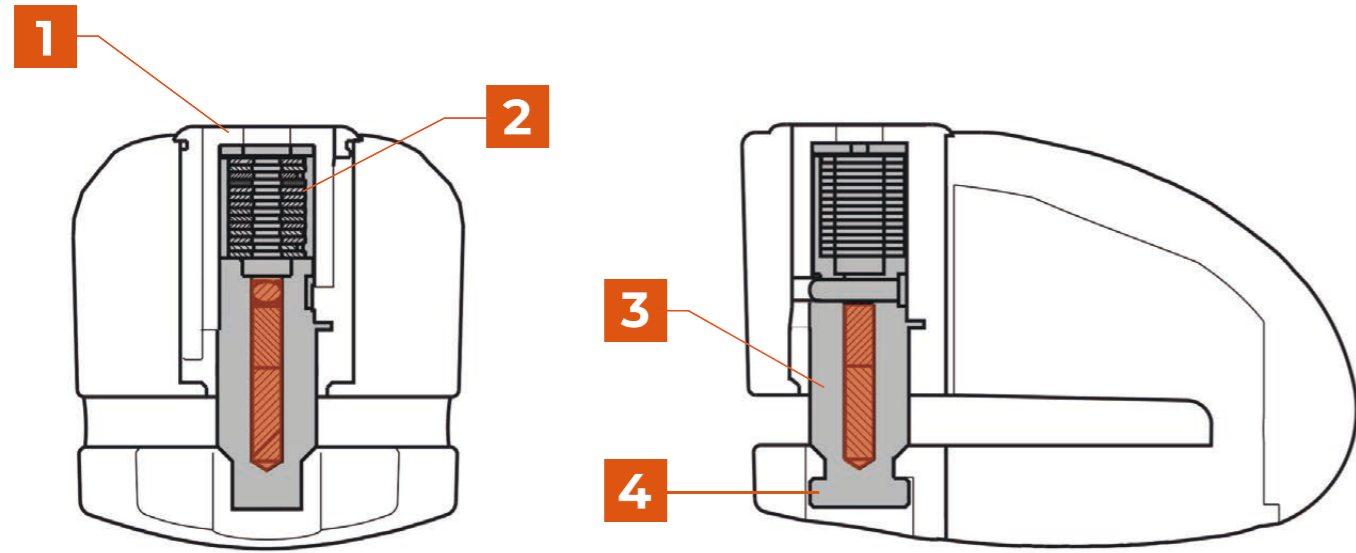

1. DISC TUMBLER LOCK MECHANISM

Composed of multiple rotating discs, only a specially cut key can turn the discs and allow the lock to open. Discs and keys are uniquely cut into over 15,000 combinations. The mutual opening rate is extremely low.

2. STAINLESS STEEL DISC PLATES

Strong material with resistance to lock picking, drilling and bumping.

3. CARBIDE REINFORCED STEEL LOCKING PIN

The locking pin has passed various tests performed by and is proven to resist bolt cutters and saw blades

4. DOUBLE LOCK MECHANISM

Twin-spar lock chassis for double strength, cut and to resistance.



OVERLORD



KNX15
ALARM DISC LOCK



Built-in 120dB anti-theft security alarm
Alarm function selection ARM / DISARM



Ø14mm steel locking pin
Double locking mechanism
Pick and drill proof disc-style cylinder



Stainless steel construction
100% rust-proof lock body
Weather-proof electronic module



PACKAGE CONTENT



OVERLORD



OVERLORD



KNS6 ALARM DISC LOCK



PACKAGE CONTENT

- Built-in 120dB anti-theft security alarm
Alarm function selection ARM / DISARM
- 6 MM** Ø6mm steel locking pin
Easy pushdown-and-click locking mechanism
Pick and drill proof disc-style cylinder
- Mini size - ideal for scooters, e-bikes
Alloy steel construction
100% rust-proof lock body
Weather-proof electronic module



KNX10 ALARM DISC LOCK



- Built-in 120dB anti-theft security alarm
Alarm function selection ARM / DISARM
- 10 MM** Ø10mm steel locking pin
Double locking mechanism
Pick and drill proof disc-style cylinder
- Alloy steel construction
100% rust-proof lock body
Weather-proof electronic module

PACKAGE CONTENT



OVERLORD



OVERLORD



KNX6 ALARM DISC LOCK



PACKAGE CONTENT

- Built-in 120dB anti-theft security alarm
Alarm function selection ARM / DISARM
- 6 MM** Ø6mm steel locking pin
Easy pushdown-and-click locking mechanism
Pick and drill proof disc-style cylinder
- Alloy steel construction
100% rust-proof lock body
Weather-proof electronic module



KT6 ALARM DISC LOCK



- Built-in 120dB anti-theft security alarm
Alarm function selection ARM / DISARM
- 6 MM** Ø6mm steel locking pin
Easy pushdown-and-click locking mechanism
Pick and drill proof disc-style cylinder
- Alloy steel construction
100% rust-proof lock body
Weather-proof electronic module

PACKAGE CONTENT





KT6/CB ALARM DISC LOCK



PACKAGE CONTENT



Built-in 120dB anti-theft security alarm
Alarm function selection ARM / DISARM

6 MM Ø6mm steel locking pin
Easy pushdown-and-click locking mechanism
Pick and drill proof disc-style cylinder

Mini size - ideal for scooters
Plastic-coated manganese steel construction
100% rust-proof lock body
Weather-proof electronic module

KNN1/CB DISC LOCK



PACKAGE CONTENT



6 MM Ø6mm steel locking pin
Easy pushdown-and-click locking mechanism
Pick and drill proof disc-style cylinder

Mini size - ideal for scooters, e-bikes
Plastic-coated manganese steel construction
100% rust-proof lock body
Weather-proof electronic module

OVERLORD



KNN1 DISC LOCK



PACKAGE CONTENT



6 MM Ø6mm steel locking pin
Easy pushdown-and-click locking mechanism
Pick and drill proof disc-style cylinder

Mini size - ideal for scooters, e-bikes
Alloy steel construction
100% rust-proof lock body
Weather-proof electronic module

KNN6/CB DISC LOCK



PACKAGE CONTENT



6 MM Ø6mm steel locking pin
Easy pushdown-and-click locking mechanism
Pick and drill proof disc-style cylinder

Plastic-coated manganese steel construction
100% rust-proof lock body
Weather-proof electronic module



KN1 DISC LOCK



6 MM Ø6mm steel locking pin
Easy pushdown-and-click locking mechanism
Pick and drill proof disc-style cylinder

Mini size - ideal for scooters, e-bikes
Alloy steel construction
100% rust-proof lock body



PACKAGE CONTENT



SOLIDV



KVZ1 DISC LOCK



6 MM Ø6mm steel locking pin
Easy pushdown-and-click locking mechanism
Pick and drill proof disc-style cylinder

Alloy steel construction
100% rust-proof lock body



PACKAGE CONTENT



SOLIDV



KVC1 DISC LOCK



6 MM Ø6mm steel locking pin
Easy pushdown-and-click locking mechanism
Pick and drill proof disc-style cylinder

Steel construction
100% rust-proof lock body



PACKAGE CONTENT



SOLIDV



KVC2 DISC LOCK



14 MM Ø14mm steel locking pin
Easy pushdown-and-click locking mechanism
Pick and drill proof disc-style cylinder

Steel construction
100% rust-proof lock body



PACKAGE CONTENT



SOLIDV



KVZ2
DISC LOCK



14 MM Ø14mm steel locking pin
Double locking mechanism
Pick and drill proof disc-style cylinder

Alloy steel construction
100% rust-proof lock body



PACKAGE CONTENT



HEAVYV



KVS2
DISC LOCK



14 MM Ø14mm steel locking pin
Double locking mechanism
Pick and drill proof disc-style cylinder

Stainless steel construction
100% rust-proof lock body



PACKAGE CONTENT



HEAVYV



KVS1
DISC LOCK



6 MM Ø6mm steel locking pin
Easy pushdown-and-click locking mechanism
Pick and drill proof disc-style cylinder

Stainless steel construction
100% rust-proof lock body



PACKAGE CONTENT



smart.LOCK

Introducing the Kovix smart lock, a revolutionary security solution that offers both convenience and security. With its advanced features such as keyless unlocking through Bluetooth® 3.0 and fingerprint recognition, this lock redefines the way you secure your beloved bike. The U shackle, made from hardened steel, guarantees exceptional durability and resistance to rust, ensuring long-lasting reliability.







Experience the future of security with the Kovix smart lock – the perfect blend of convenience, durability, and advanced protection.



What sets the Kovix smart lock apart is its inbuilt 120-decibel alarm system. This advanced feature actively detects any movement, effectively deterring tampering and amplifying security. The lock also allows for easy access sharing, making it perfect for scenarios where multiple users need access to the same lock.



KSC-U2i SMART U LOCK

-  Fingerprint Unlock
-  Built-in 120dB anti-theft security alarm
-  Location tracking
-  Authorization
-  14mm stainless- steel U shackle
-  IP67 waterproof



DIMENSIONS (MM)

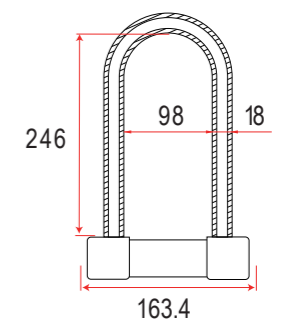

U LOCK

Sturdy hardened steel shackle U lock resists hand tools, bolt cutters, and lever attacks. Built-in shock-motion activated 120 decibels alarm powered by a long-life CR2 lithium battery for high-performance in all conditions.



KTL16-210 U LOCK



Built-in 120dB anti-theft security alarm
Alarm function selection ARM / DISARM



Ø16*210mm hardened steel shackle
Cutting and sawing resistant
Pick and drill proof disc-style cylinder



Alloy steel construction
Protective vinyl coating
100% rust-proof lock body
Weather-proof electronic module



PACKAGE CONTENT



KTL14-150 U LOCK



Built-in 120dB anti-theft security alarm
Alarm function selection ARM / DISARM



Ø14*150mm hardened steel shackle
Cutting and sawing resistant
Pick and drill proof disc-style cylinder



Alloy steel construction
Protective vinyl coating
100% rust-proof lock body
Weather-proof electronic module



PACKAGE CONTENT





CHAIN & CABLE LOCK

Rugged steel chains and cables are available in various thicknesses and lengths offering many ways of locking motorcycles or bikes to fixed objects. Built-in shock-motion activated 120 decibels alarm powered by a long-life CR2 lithium for high-performance in all conditions.

KTL14-300 U LOCK



Built-in 120dB anti-theft security alarm
Alarm function selection ARM / DISARM

**14
MM**

Ø14*300mm hardened steel shackle
Cutting and sawing resistant
Pick and drill proof disc-style cylinder



Alloy steel construction
Protective vinyl coating
100% rust-proof lock body
Weather-proof electronic module

PACKAGE CONTENT





KCL08-120 CHAIN LOCK



Built-in 120dB anti-theft security alarm
Alarm function selection ARM / DISARM

**8
MM**

Ø8*1200mm reinforced hardened steel chain
Cloth chain protective cover
Pick and drill proof disc-style cylinder



Steel construction
100% rust-proof lock body
Weather-proof electronic module



PACKAGE CONTENT



KCL10-150 CHAIN LOCK



Built-in 120dB anti-theft security alarm
Alarm function selection ARM / DISARM

**10
MM**

Ø10*1500mm reinforced hardened steel chain
Cloth chain protective cover
Pick and drill proof disc-style cylinder



Steel construction
100% rust-proof lock body
Weather-proof electronic module



PACKAGE CONTENT



KCL10-120 CHAIN LOCK



Built-in 120dB anti-theft security alarm
Alarm function selection ARM / DISARM

**10
MM**

Ø10*1200mm reinforced hardened steel chain
Cloth chain protective cover
Pick and drill proof disc-style cylinder



Steel construction
100% rust-proof lock body
Weather-proof electronic module



PACKAGE CONTENT



KCL12-120 CHAIN LOCK



Built-in 120dB anti-theft security alarm
Alarm function selection ARM / DISARM

**12
MM**

Ø12*1200mm reinforced hardened steel chain
Cloth chain protective cover
Pick and drill proof disc-style cylinder



Steel construction
100% rust-proof lock body
Weather-proof electronic module



PACKAGE CONTENT





KCL12-150 CHAIN LOCK

PACKAGE CONTENT

KWL24-170 CABLE LOCK

PACKAGE CONTENT

- Built-in 120dB anti-theft security alarm
Alarm function selection ARM / DISARM
- 12 MM** Ø12*1500mm reinforced hardened steel chain
Cloth chain protective cover
Pick and drill proof disc-style cylinder
- Steel construction
100% rust-proof lock body
Weather-proof electronic module



- Built-in 120dB anti-theft security alarm
Alarm function selection ARM / DISARM
- 24 MM** Ø24*1700mm braided steel cable protected
With PVC external glue
Pick and drill proof disc-style cylinder
- Steel construction
100% rust-proof lock body
Weather-proof electronic module



KWL24-110 CABLE LOCK

PACKAGE CONTENT

- Built-in 120dB anti-theft security alarm
Alarm function selection ARM / DISARM
- 24 MM** Ø24*1100mm braided steel cable protected
With PVC external glue
Pick and drill proof disc-style cylinder
- Steel construction
100% rust-proof lock body
Weather-proof electronic module





GRIP LOCK

Compact, lightweight, and sturdy grip lock. Convenient to carry along on every r
The 10mmCarbide reinforced hardened steel locking pin and built-in 120dB anti-theft security alarm offer dual tactile and audible security.





KHL GRIP LOCK

-  Built-in 120dB anti-theft security alarm
Alarm function selection ARM / DISARM
-  Ø10mm steel locking pin
Easy pushdown-and-click locking mechanism
Pick and drill proof disc-style cylinder
-  Alloy steel construction
100% rust- proof lock body
Weather-proof electronic module

PACKAGE CONTENT



KGH GRIP LOCK

-  Built-in 120dB anti-theft security alarm
Alarm function selection ARM / DISARM
-  Ø10mm steel locking pin
Easy pushdown-and-click locking mechanism
Pick and drill proof disc-style cylinder
-  Nylon construction
100% rust- proof lock body
Weather-proof electronic module

PACKAGE CONTENT



GROUND ANCHOR

Solid ground anchor secure to the floor and acts as a point of reference for a
Full stainless steel construction resists all forms of attack.



STAINLESS
STEEL



KGA GROUND ANCHOR

**112
MM** 112mm stainless steel case resists all forms of attack
Double-locking mechanism
Pick and drill proof disc-style cylinder



Stainless steel construction
100% rust-proof lock body

PACKAGE CONTENT





ACCESSORIES

Safeguard your valuable helmet, preventing theft and protecting it from damage.



KPM001
MIRROR MOUNT



-  360° rotation
-  One-click auto-locking mechanism
Vibration damper design
-  Anti-theft design



PACKAGE CONTENT



KHEL200
HELMET LOCK

-  Password unlock
2m Extended Cable
-  Alloy lock body
Corrosion resistance





PACKAGE CONTENT



BRANDED MERCHANDISE



KHEL100
HELMET LOCK

-  Password unlock
1m Extended Cable
-  Alloy lock body
Corrosion resistance



PACKAGE CONTENT



KBR-1

- L: 220mm
- W: 220mm
- H: 220mm
- Weight: 1005g



- L: 8mm
- H: 10mm
- Weight: 146g

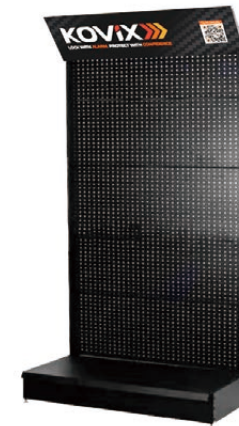

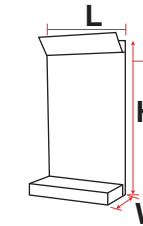

K040

- L: 1000mm
- W: 450mm
- H: 2000mm
- Weight: 33kg



KZTL
COMBINATION LOCK

-  Password unlock
-  Adjust the tightness freely
-  Reinforced steel core
Corrosion resistance



PACKAGE CONTENT

